

**A**

**B**

**C**

**D1**

**D2**

**E**

**F**

**CAGU10R11**

**NOT INCLUDED**

0.5 mm = 0.75 mm

**+KFLEX...**

**KFLEX...**

**TUTORIAL**

**NOT INCLUDED**

**N**

**O**

**S**

**P**

**Q1**

**Q2**

**R1**

**R2**

**H**

**1**

**R2**

**O**

**2**

**3**

**x2**

**4**

**5**

**6**

**7.8 mm**

**7.8 mm**

**7**

**A**

**8**

**R1**

**Q1**

**C**

**9**

**C**

**10**

**D1**

**11**

**D2**

**12**

**13**

**x2**

**14**

**15**

**16**

**17**

**18**

**x2**

**19**

**F**

**CAGU10R11**

**20**

**B**

**KBR57FC...**

**T1**

**T2**

**V**

**U**

**NOT INCLUDED**

**21**

**T2**

**R2**

**22**

**E**

**D**

**23**

**24**

**S**

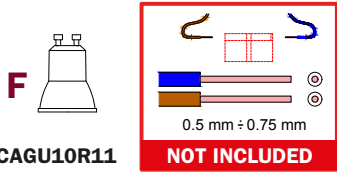
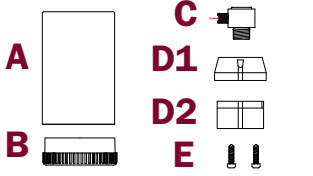
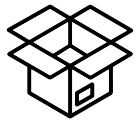

**1**

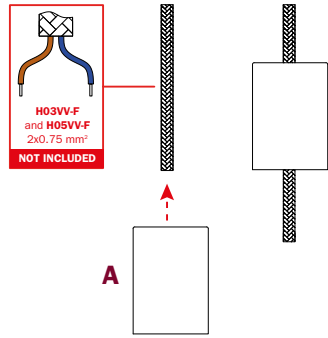

**2**

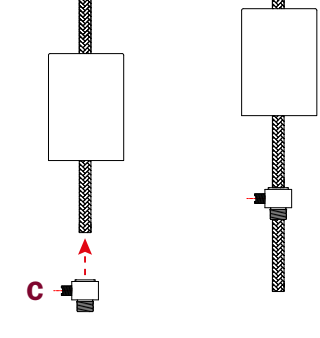

**3**

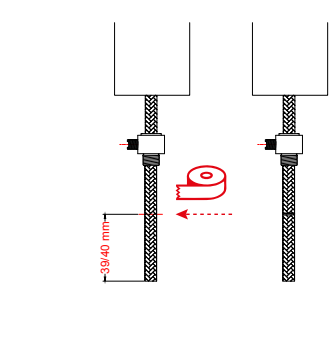

**4**

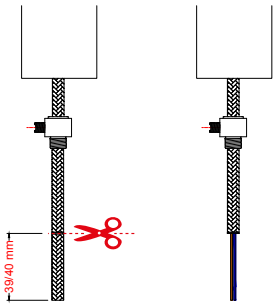

**5**

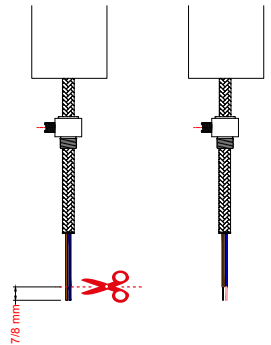

**6**

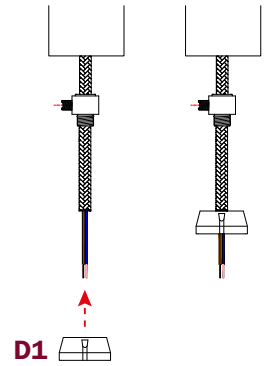

**7**

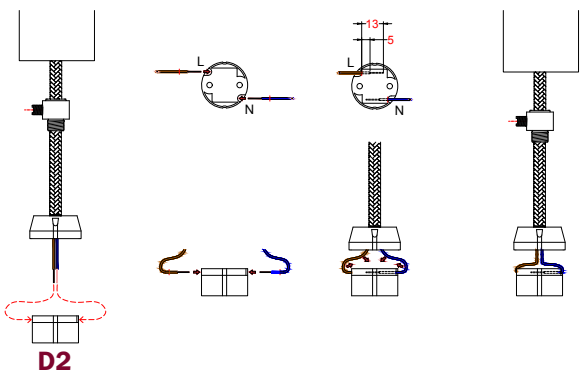

**8**

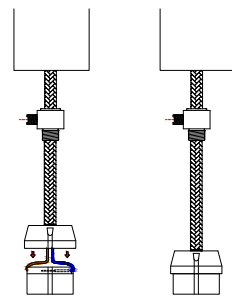

**9**

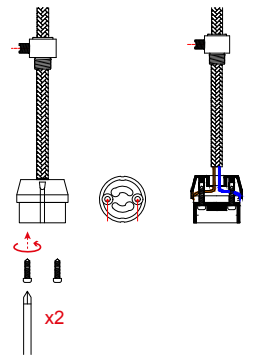

**10**

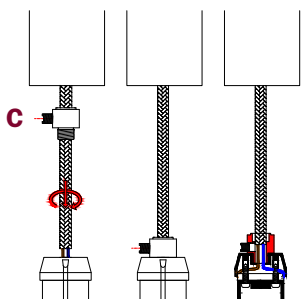

**11**

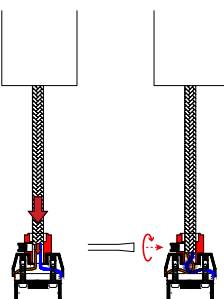

**12**

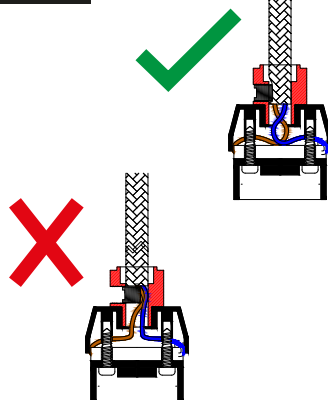

**13**

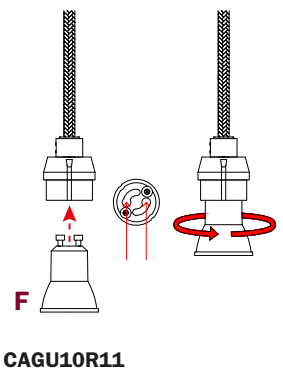

14

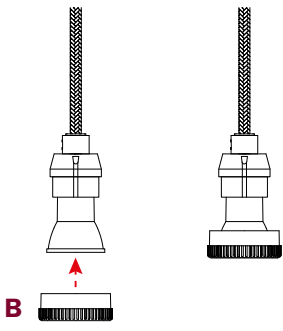

15

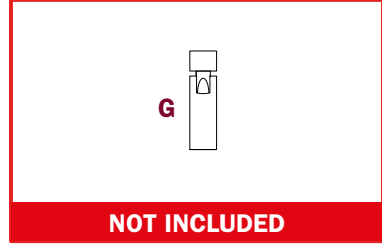
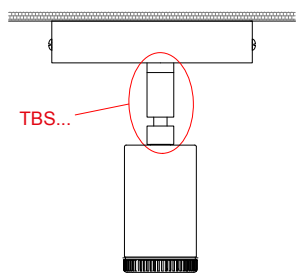
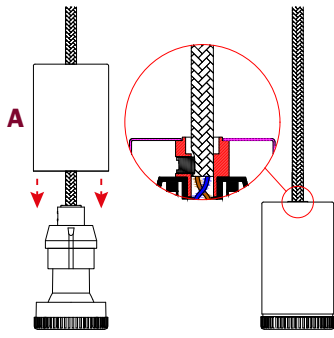

NOT INCLUDED

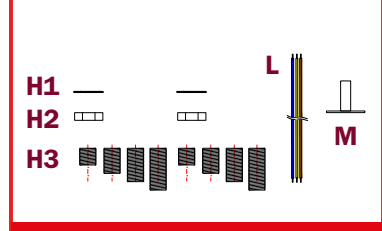

NOT INCLUDED

16

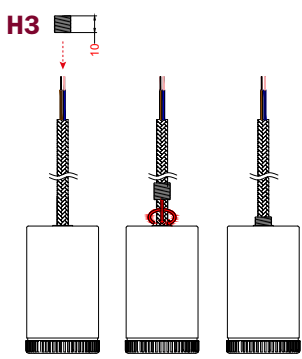

17

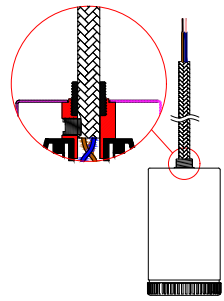

18

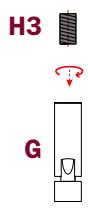

19

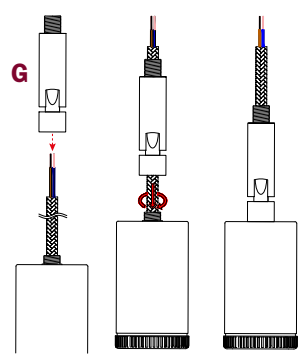

20

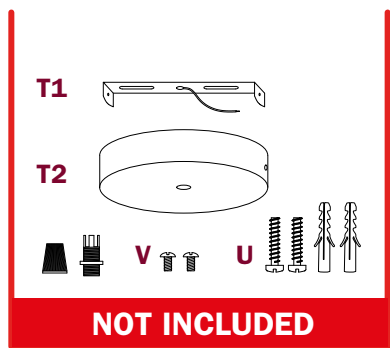
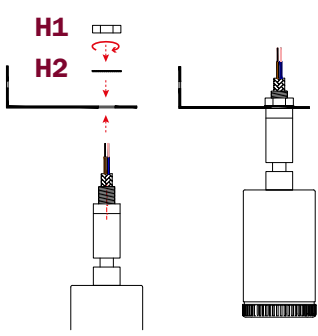

21

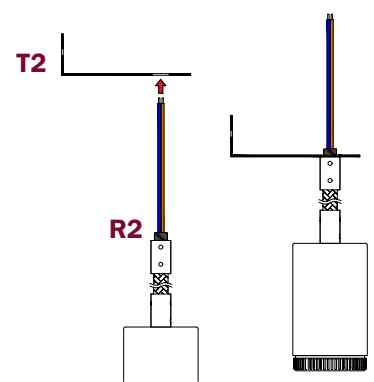

22

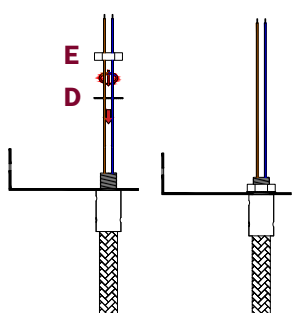

23

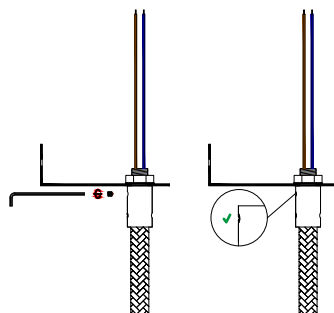

24

